KCB1E1E1E1E5678W (ORDER NO. 050022)

Series KC...

- ▶ Screw terminal
- ▶ 8 actuating directions
- ▶ Bellows for panel mounting (W)



Description

Function drawings

		0	I	II			0	I	II
A	1				F	1			
	2					2			
	3					3			
B	1				G	1			
	2					2			
	3					3			
C	1				H	1			
	2					2			
	3					3			
D	1				K	1			
	2					2			
	3					3			
E	1								
	2								
	3								

Dimension drawings

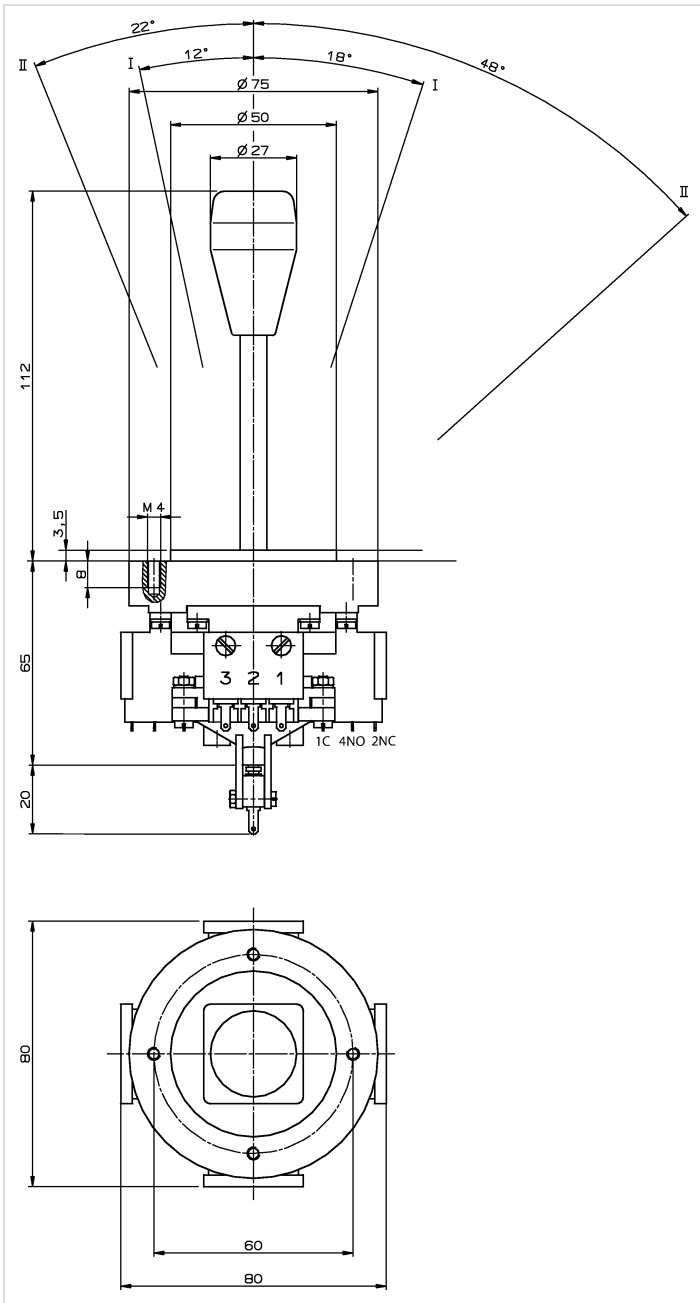

Dimension drawings

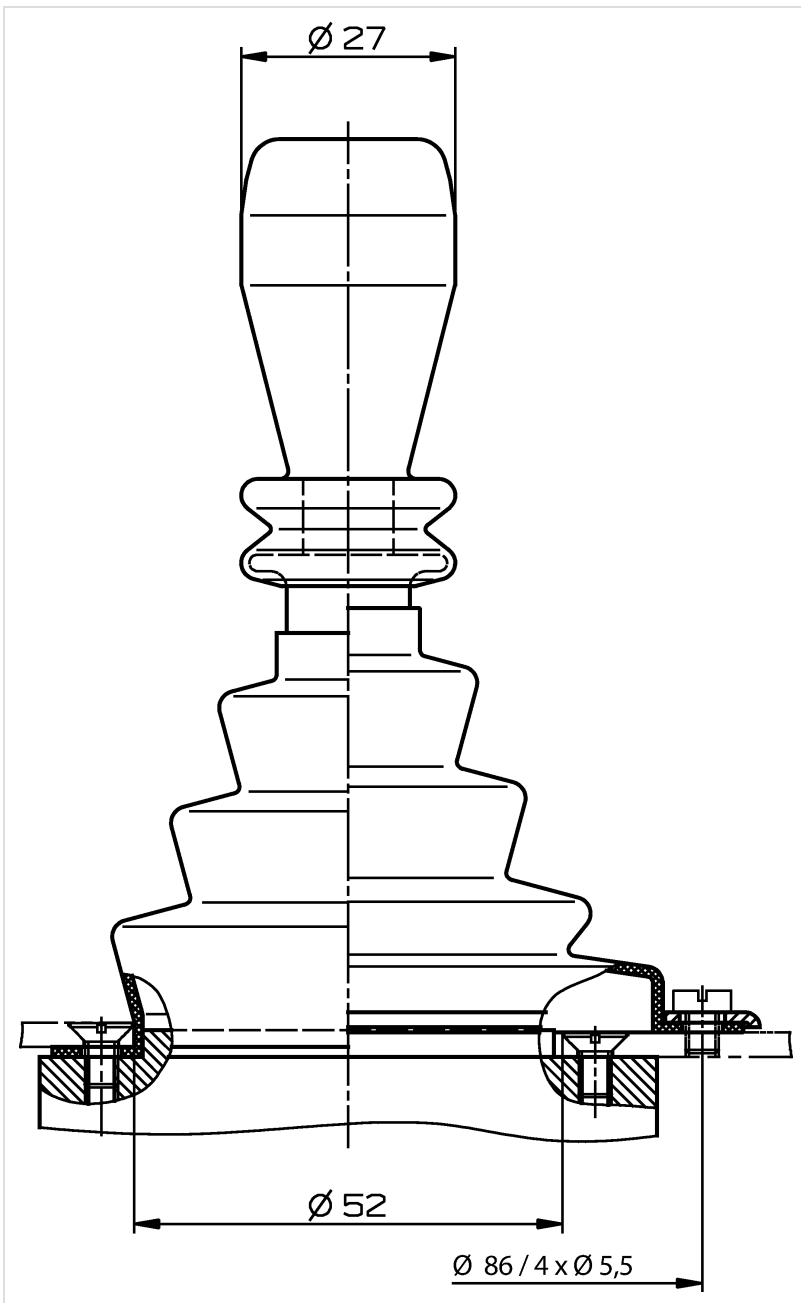

Connection examples

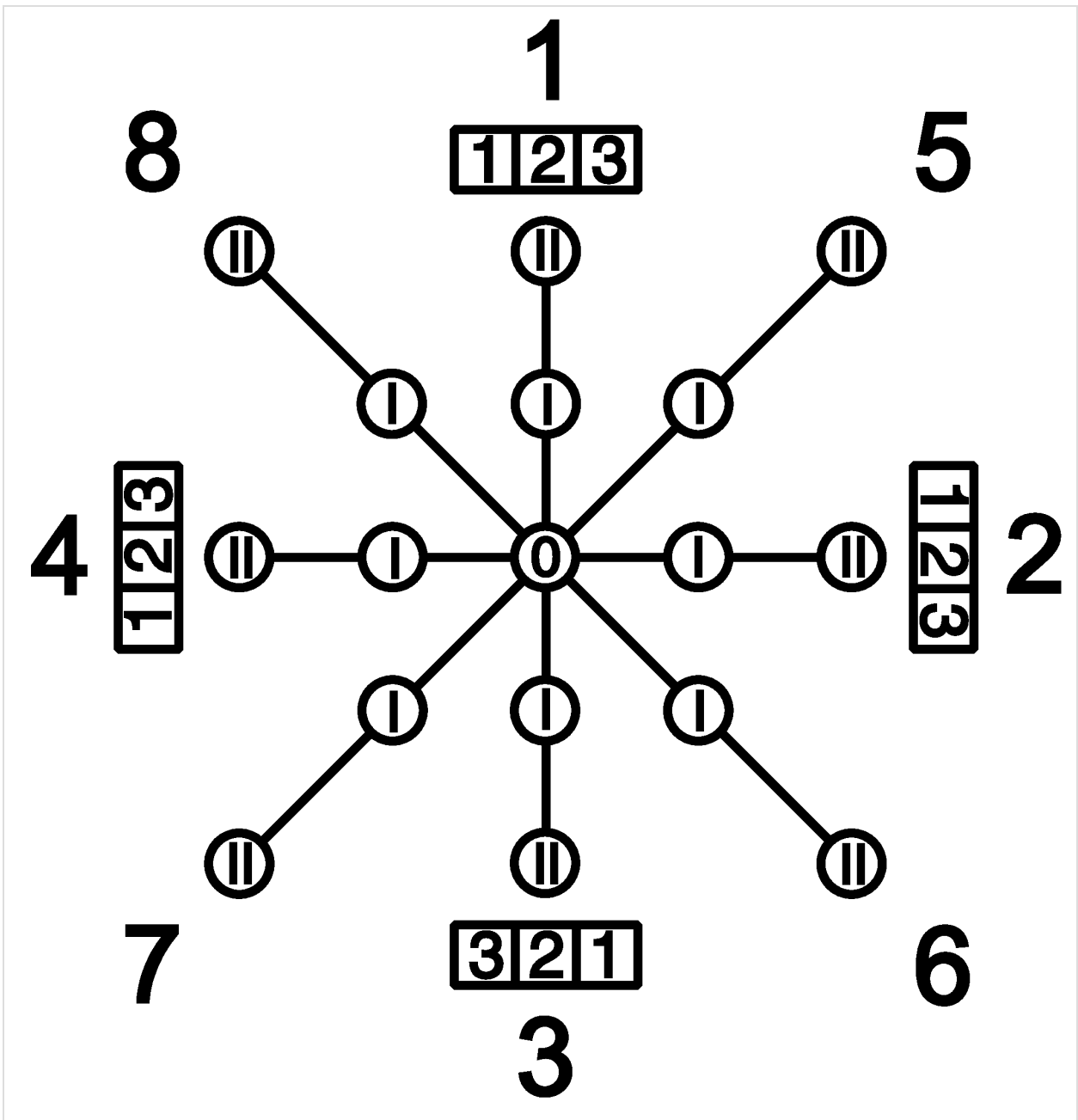

Connection examples

ES 587

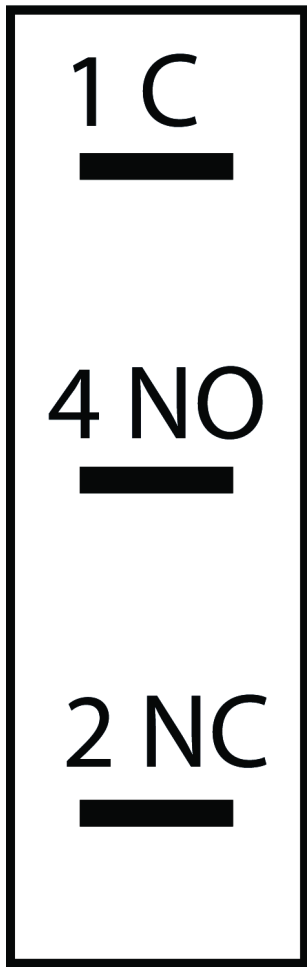

ES 556



Connection examples

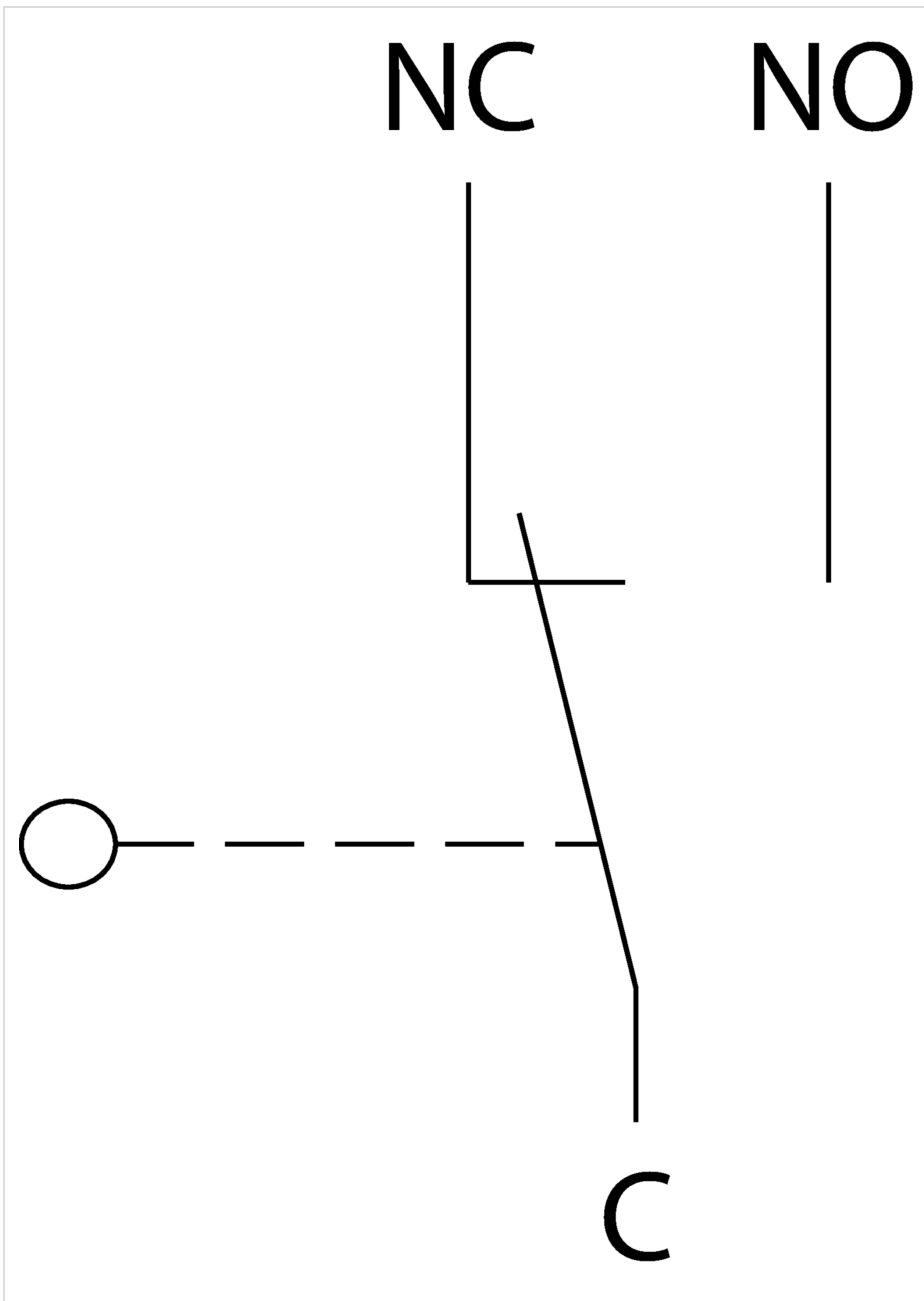

Technical data

Approvals



Electrical connection ratings

Rated impulse withstand voltage U_{imp}	2.5 kV
Rated insulation voltage U_i	250 V
Short circuit protection according to IEC 60269-1	T6/F10
Switching current	
	(at 24V) min. 12 mA
Switching voltage	min. 10 V
Utilization category	
	AC-15 230V 4A
	DC-13 24V 2A

Mechanical values and environment

Actuating directions	max. 8 max. 3 positions (0-1-2) possible per type and direction
Ambient temperature	-5 ... +65 °C
Connection	Screw terminal
Degree of protection	on the front with bellows IP65 (Version W)
Material	Contact Silver alloy
	Bellows elastomer, black (Low PAH)
	Housing thermoplastic/aluminum
	Switching lever galvanized steel
Mechanical life	1 x 10 ⁶
Mounting type	Panel cut-out depending on version X or W (see panel cut-out drawing)
Number of monitoring contacts	max. 4 4 (4 directions x 1 switching element)
Switching principle	Changeover contact C, IEC 947-5-1 (Snap-action contact element, design ES556)

Miscellaneous

Additional feature	Bellows W for panel mounting
--------------------	------------------------------

Contacts

 EUCHNER GmbH + Co. KG
 Kohlhammerstraße 16
 70771 Leinfelden-Echterdingen

 +49 711 7597-0

 +49 711 753316

 info(at)euchner.de